

Institute for Defense Analyses

4850 Mark Center Drive • Alexandria, Virginia 22311-1882

Mission Effectiveness Methodology in Operational Testing

**for the 32nd ITEA Symposium
20 August 2015**

Kristen L. Lambrecht

Bruce A. Simpson



IDA What is our Test and Evaluation Mandate?

- **Title 10 defines Operational Test and Evaluation**
 - Field test under realistic combat conditions
 - By typical military units equipped with the system
 - For the purpose of determining effectiveness and suitability for use in combat
- **Defense Acquisition Guidebook defines Operational Effectiveness**
 - Overall degree of mission accomplishment of a system when used by representative personnel
 - In an operational environment considering organization, training, doctrine, tactics, survivability or operational security, vulnerability, and threat
- **Guiding principles with which we develop mission-based metrics for evaluating systems**
- **Test a trained unit employing a system in an operationally representative environment with a focus on end-to-end mission evaluation**

IDA $\sum_{i=0}^n \text{Requirements}_i \neq \text{Mission Accomplishment}$

- **Sometimes it's possible to meet all requirements and not be able to provide military utility**
 - Future Combat Systems (FCS) Tactical Unattended Ground Sensor (T-UGS) and Urban UGS (U-UGS)
- **Requirements documents are usually a list of technical specifications**
 - Contractors need specifications to build to that can be easily verified
 - Not a comprehensive list
- **Important aspects of mission accomplishment are not in the requirements documents**
 - Doctrine, training, and integration
 - Evolving threat
 - Organization, tactics, survivability or operational security, and vulnerability

IDA Where Can We Find Mission-Based Metrics?

- **How do we define mission accomplishment without “creating new requirements”?**
 - Capabilities Production Documents are written in terms of technical specifications
 - Critical Operational Issues are *supposed to* include operational metrics, however they generally:
 - » Do not include measurable operational metrics
 - » Simply restate technical requirements
 - **Mission Essential Task Lists provide training standards**
 - Don't test system capabilities
 - Subjective
 - Not quantifiable
 - **Need to find a way to combine the two in a meaningful quantitative way**
 - There is no one size fits all approach
 - Creating objective, quantitative metrics is hard!!!
-

Unit Equipped with the system

System

Capability

Artillery platoon

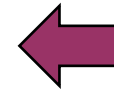
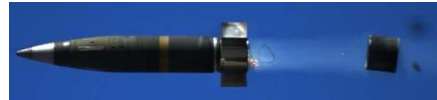
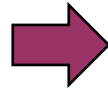

Excalibur

Improved miss distance

Unmanned Aerial Vehicle Company

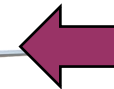
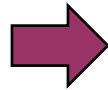

Gray Eagle UAV

New payload and improved endurance

Infantry platoon

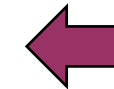
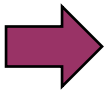

Raven UAV

New program and capability provide intel to ground units

Infantry company(s)

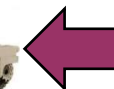
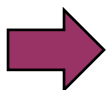

Bradley A4 & Abrams M1A2 SEPv3

Upgraded radios and mission command

Where Do We Draw the Box? (Gray Eagle UAV)

- Gray Eagle is organized as a company in the Combat Aviation Brigade and a Division asset, but it usually pushed down to the maneuver Brigades
- Who is the end user of the information provided?

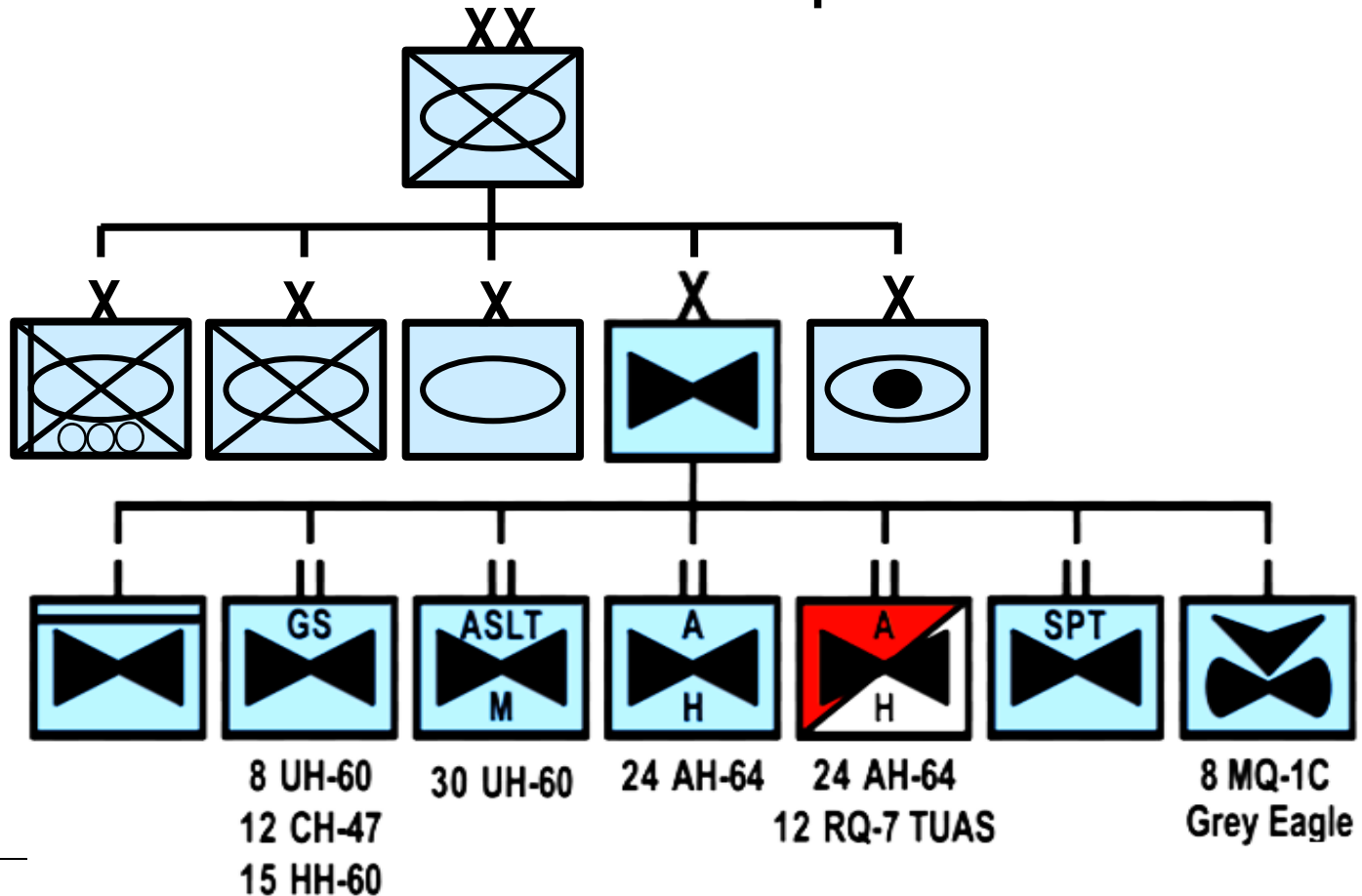

Where Do We Draw the Box? (M2A4 Bradley and M1A2 SEP v3 Abrams)

- Ground Combat Systems are typically organized in units from squads/crews up to brigades
- What is the scope of the capability being tested?

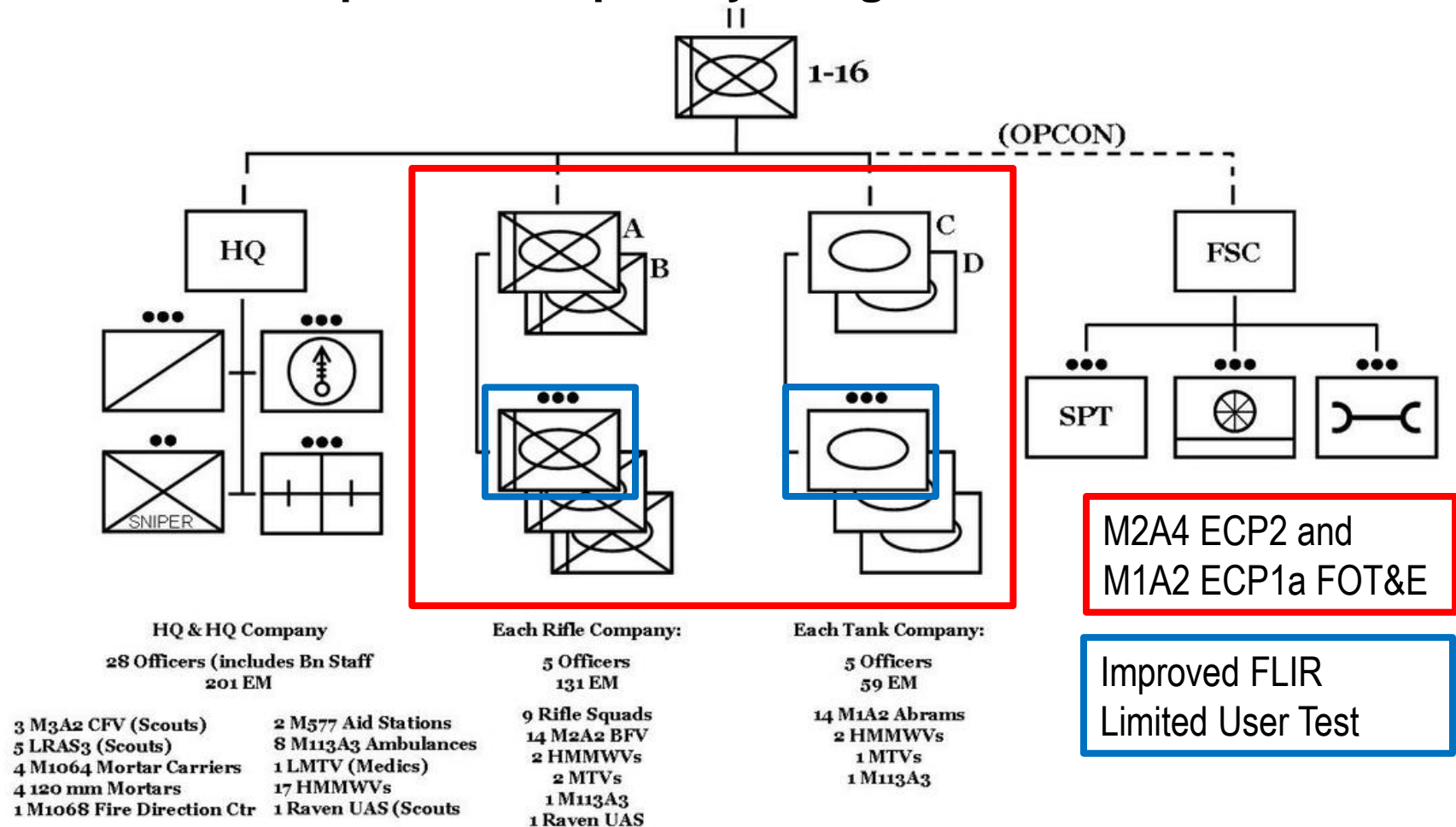

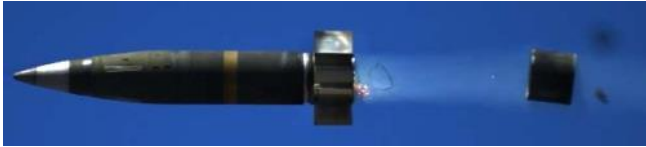

- **Test: Initial Operational Test and Evaluation**
- **Requirements: Mission Effects, accuracy and timeliness**

- **End-to-End Mission:**

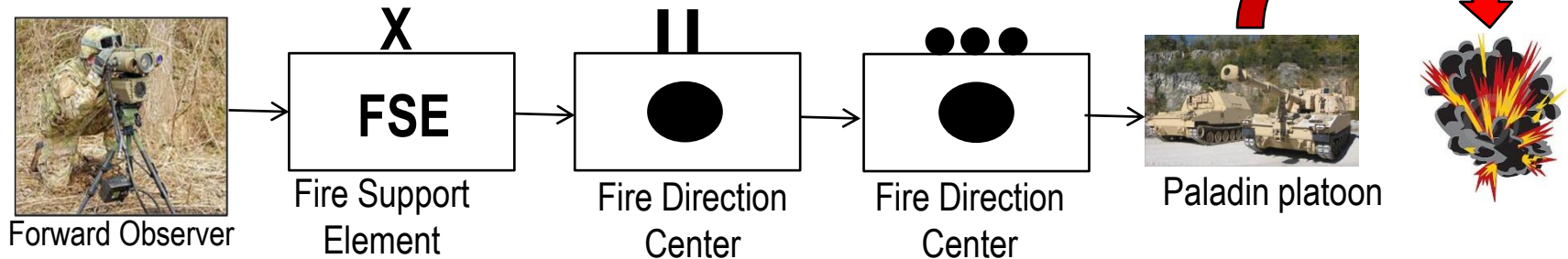

- **Metrics**

- Did Excalibur achieve desired effects on target? (binary)
- What is the accuracy? (continuous)
- What is the timeliness; how long did it take to execute a mission? (continuous)

Example 2: M2A4 Bradley and M1A2 SEPv3 ECP 1a Abrams



- **Test: Follow-on Test and Evaluation**
- **Requirements: Mitigate size, weight, and power limitations, integrate C2 upgrades but do not degrade existing capabilities**
- **End-to-End Mission: Combat arms missions, i.e., assault, breach, screen, etc.**

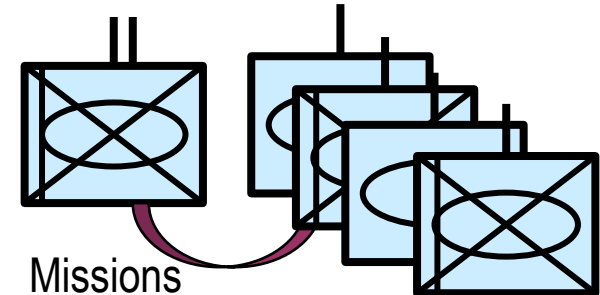

- **Metrics**

- Mission accomplishment (task and purpose based on unit order)
 - » Likert Scale to evaluate both task/mission accomplishment and purpose/commander's intent
 - » Contribution of system to unit mission accomplishment
- Blue losses – vehicles, soldiers.
- Red losses – vehicles, soldiers.
- Fratricide/Civilian/non-combatant losses.



- **Test: Follow-on Operational Test and Evaluation**
- **Requirements: Target location error, sensor performance, flight performance**
- **End-to-End Mission:**

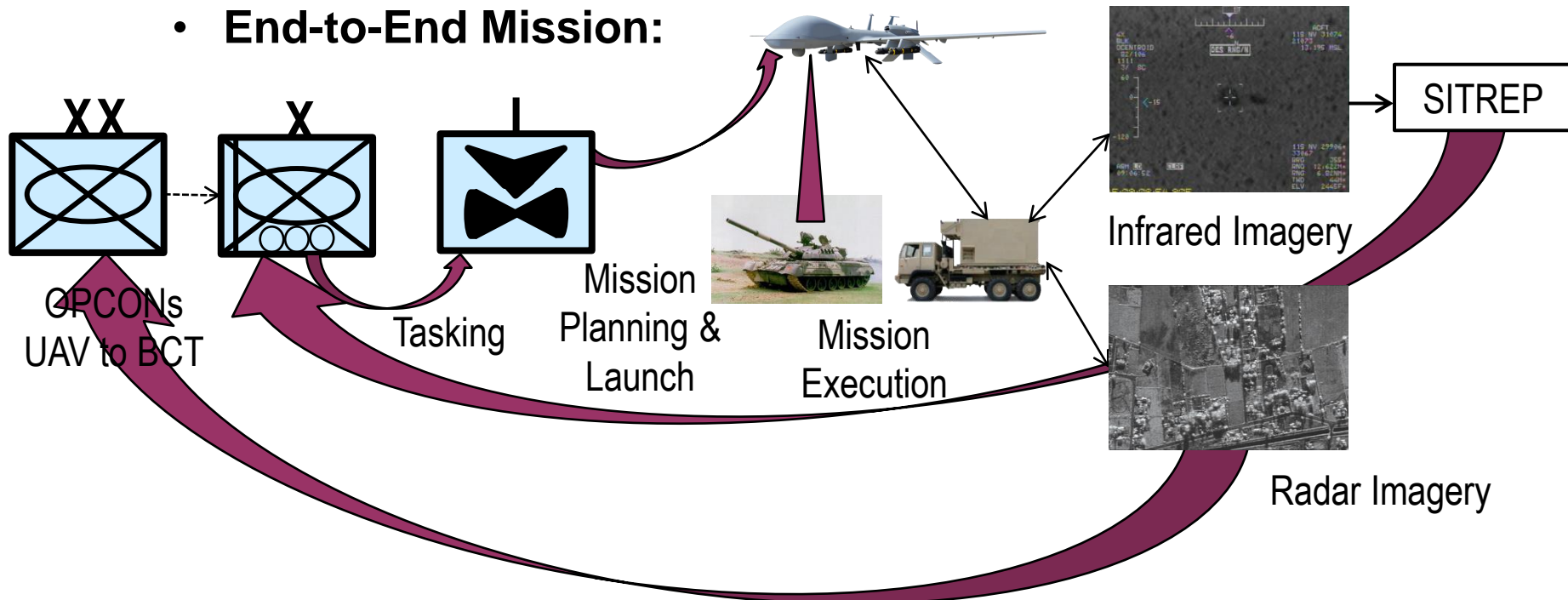



- **Metrics:**
 - Was the information provided in the SITREP timely?
 - » Measured in terms of the what the requester would deem as actionable
 - Was the information provided in the SITREP accurate?
 - » Measured in terms of the target location error
 - Was the information provided in the SITREP complete?
 - » Did the report contain sufficient essential elements of information to correctly determine the composition of the target? (sensor performance)
 - Did the report contribute to answering the commander's intelligence requirements?



- **Test: Initial Operational Test and Evaluation**
- **Requirements: Target location error, sensor performance, flight performance**
- **End-to-End Mission:**

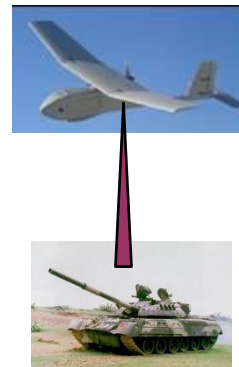
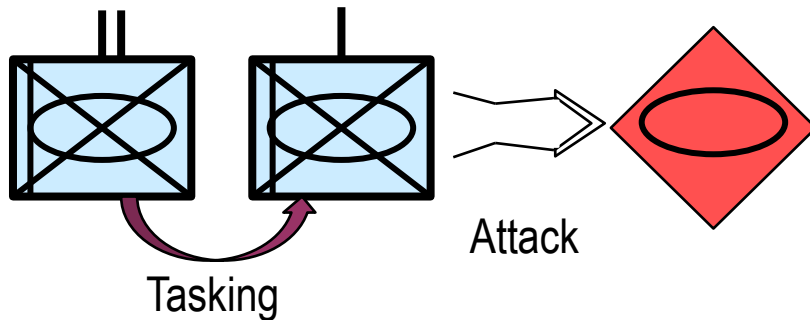

- **Metrics:**
 - Does the information provided by the SUAV enhance the likelihood of Mission Success?
 - Does the information provided by the SUAV reduce blue casualties?
 - Does the information provided by the SUAV increase red casualties?
 - Does the information provided by the SUAV help avoid or reduce fratricide?

- **Mission-based metrics aren't usually found in the requirements**
- **Developing mission-based metrics can be challenging**
- **Focus on the unit equipped with the system**